

ON-2250

Power by CUMMINS

QSK60-G7

Prime power: 2250KVA/1800KW

Standby power: 2500KVA/2000KW

GENERATING POWER SOLUTIONS

Increased availability for new operations

Reliable, robust and versatile generator.
Ready to deliver power for a next job.

Increased uptime during operations

Once installed on the end-user-site, the generator will be ready to run: "peace of mind" operation.

Reduced transport and installation costs

The compact and robust design with integrated transport features enables faster and safer transport and installation.

Reduced service & maintenance costs

Longer service intervals.
Quicker and more efficient service jobs.

Premium resale value

Designed and built to last.

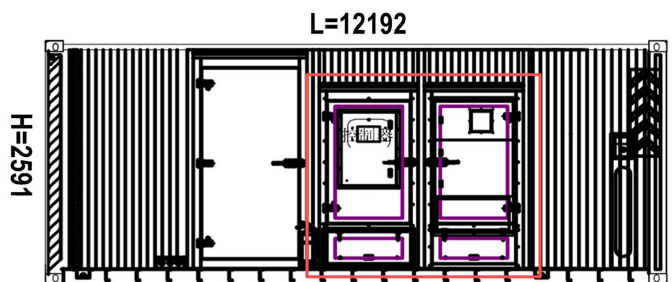

DIMENSION			OPEN TYPE	SILENT TYPE
Length (L)	mm	6200	12192	
Width (W)	mm	2850	2438	
Height (H)	mm	3290	2591	
Dry weight	kg	NA	NA	
Fuel tank	L	NA	NA	

ONEWPOWER

WWW.ONEWPOWER.COM

Technical Data

Model ON-2250

Rated prime power	KW	1800
Rated standard power	KW	2000
Rated voltage line to line	V	220~480
Maximun sound level	dB(@7m)	≤72

Engine

Model		QSK60-G7
Aspiration		Turbocharged, aftercooled
Fuel system		Cummins HPI
No. cylinders		16
Displacement	Liquid	60.2
Bore*Stroke	mm	159*190
Compression ratio		14.5:1
Rated speed	r/min	1800
Rated net power(with fan)	Kw	2000
Governor type		Electronic

Exhaust system

Exhaust gas flow		TBD
Exhaust gas temp	° F (° C)	<432
Max back pressure		10KPA

Aspiration system

Max inlet pressure	kPa	≤3.5
Combustion volume	L/s	/
Air flow		TBD

Fuel system

100% load(Prime power)	L/h	471
75% load(Prime power)	L/h	360
50% load(Prime power)	L/h	254
Fuel tank capacity	L	2000

Lubrication system

Oil capacity	L	280
Oil consumption	g/kwh	28.3
Oil pressure	kPa	10
(continuous operation)		

Cooling system

Coolant capacity	L	TBD
Thermostat operation range	°C	76-88
Max water temperature	°C	98

Alternator

Model **S9H1D-C4**

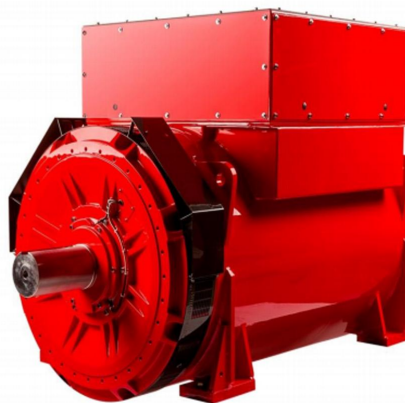

Controller

Model

Protective functions:

- Low oil pressure
- High water temperature
- High/low voltage
- High Engine Temperature and Overspeed.
- Voltage regulator frequency regulator
- Emergency stop
- Start failure



Control Module Options



- Auto generator control module
- Control module with "Three Remote Control" functions
- ATS auto load transfer screen
- Synchronising control modules
- Power output cabinet

S9H1D-C4 Wdg.91 - Technical Data Sheet

Standards

STAMFORD industrial alternators meet the requirements of the relevant parts of the IEC EN 60034 and the relevant section of other international standards such as BS5000, VDE 0530, NEMA MG1-32, IEC34, CSA C22.2-100 and AS1359. Other standards and certifications can be considered on request.

Quality Assurance

Alternators are manufactured using production procedures having a quality assurance level to BS EN ISO 9001.

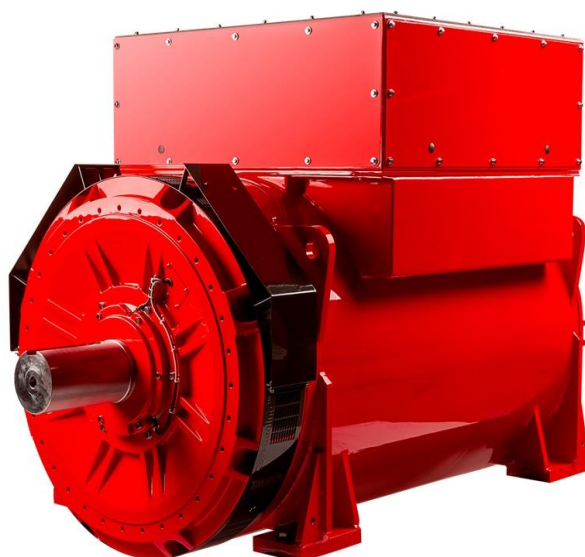

Excitation and Voltage Regulators

Excitation System					
AVR Type	DM110	DECS100	DECS150		
Voltage Regulation	± 0.25%	± 0.25%	± 0.25%		with 4% Engine Governing
AVR Power	PMG	PMG	PMG		

No Load Excitation Voltage (V)	11.2
No Load Excitation Current (A)	1.02
Full Load Excitation Voltage (V)	39.2
Full Load Excitation Current (A)	3.56
Exciter Time Constant (seconds)	0.34

STAMFORD®

S9H1D-C4 Wdg.91

Electrical Data				
Insulation System	H			
Stator Winding	Double Layer Lap			
Winding Pitch	5/6			
Winding Leads	6			
Winding Number	91			
Number of Poles	4			
IP Rating	IP23			
RFI Suppression	BS EN 61000-6-2 & BS EN 61000-6-4, VDE 0875G, VDE 0875N. Refer to factory for others			
Waveform Distortion	NO LOAD < 1.5% NON-DISTORTING BALANCED LINEAR LOAD < 5.0%			
Short Circuit Ratio	1/Xd			
Steady State X/R Ratio	21.96			
60 Hz				
Telephone Interference	TIF<50			
Cooling Air Flow	3.33 m³/sec			
Voltage Star (V)	12470	13200	13800	-
Voltage Parallel Star (V)	-	-	-	-
Voltage Delta (V)	-	-	-	-
kVA Base Rating (Class H) for Reactance Values (kVA)	2710	2870	3000	-
Saturated Values in Per Unit at Base Ratings and Voltages				
Xd Dir. Axis Synchronous	2.22	2.10	2.01	-
X'd Dir. Axis Transient	0.22	0.21	0.20	-
X''d Dir. Axis Subtransient	0.16	0.15	0.14	-
Xq Quad. Axis Reactance	1.23	1.16	1.11	-
X''q Quad. Axis Subtransient	0.30	0.29	0.28	-
XL Stator Leakage Reactance	0.19	0.18	0.17	-
X2 Negative Sequence Reactance	0.28	0.27	0.25	-
X0 Zero Sequence Reactance	0.13	0.13	0.12	-
Unsaturated Values in Per Unit at Base Ratings and Voltages				
Xd Dir. Axis Synchronous	2.67	2.52	2.41	-
X'd Dir. Axis Transient	0.26	0.24	0.23	-
X''d Dir. Axis Subtransient	0.18	0.17	0.16	-
Xq Quad. Axis Reactance	1.26	1.19	1.14	-
X''q Quad. Axis Subtransient	0.37	0.35	0.33	-
XL Stator Leakage Reactance	0.21	0.20	0.19	-
Xlr Rotor Leakage Reactance	0.00	0.00	0.00	-
X2 Negative Sequence Reactance	0.34	0.32	0.30	-
X0 Zero Sequence Reactance	0.16	0.15	0.14	-

STAMFORD®

S9H1D-C4 Wdg.91

Time Constants (Seconds)		
T'd Transient Time Const.	0.232	
T''d Sub-Transient Time Const.	0.0200	
T'do O.C. Field Time Const.	2.53	
Ta Armature Time Const.	0.0570	
T''q Sub-Transient Time Const.	0.0230	
Resistances in Ohms (Ω) at 22°C		
Stator Winding Resistance (Ra), per phase for series connected	0.5960	
Rotor Winding Resistance (Rf)	0.53	
Exciter Stator Winding Resistance	9.8	
Exciter Rotor Winding Resistance per phase	0.014	
PMG Phase Resistance (Rpmg) per phase	3.8	
Positive Sequence Resistance (R1)	0.7450	
Negative Sequence Resistance (R2)	0.8582	
Zero Sequence Resistance (R0)	0.7450	
Saturation Factors	13800V	
SG1.0	0.2	
SG1.2	0.84	
Mechanical Data		
Shaft and Keys	All alternator rotors are dynamically balanced to better than BS6861: Part 1 Grade 2.5 for minimum vibration in operation. Two bearing generators are balanced with a half key.	
	1 Bearing	2 Bearing
SAE Adaptor	0, 00	0, 00, None
Moment of Inertia	80.2 kgm ²	76.8 kgm ²
Weight Wound Stator	1787kg	1787kg
Weight Wound Rotor	1908kg	1809kg
Weight Complete Alternator	5250kg	5200kg
Shipping weight in a Crate	5600kg	5550kg
Packing Crate Size	260 x 200 x 220(cm)	260 x 200 x 220(cm)
Maximum Over Speed	2250 RPM for two minutes	
Bearing Drive End	-	6232
Bearing Non-Drive End	6324	6324

STAMFORD®

S9H1D-C4 Wdg.91

THREE PHASE EFFICIENCY CURVES

60Hz

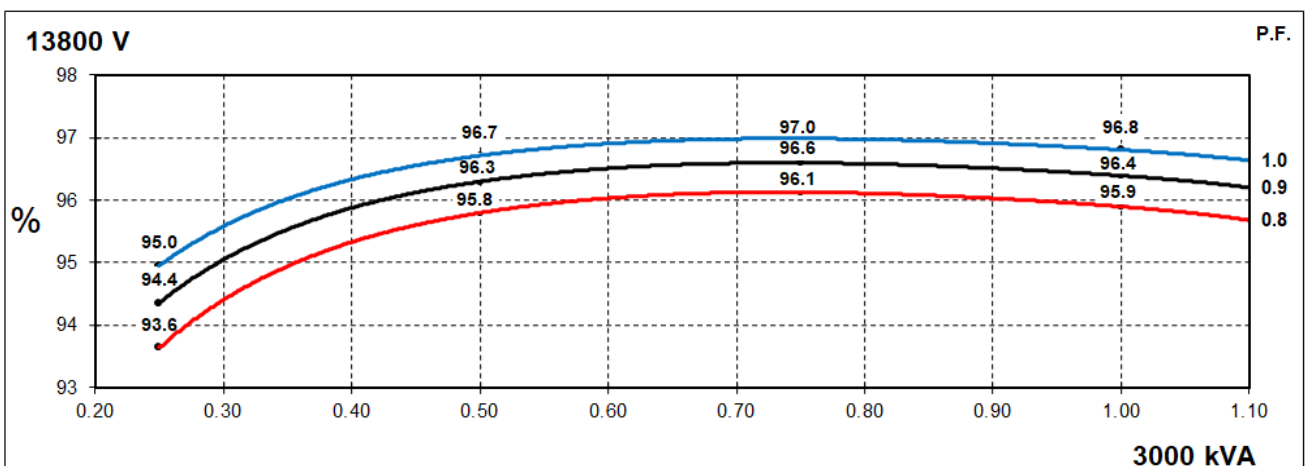
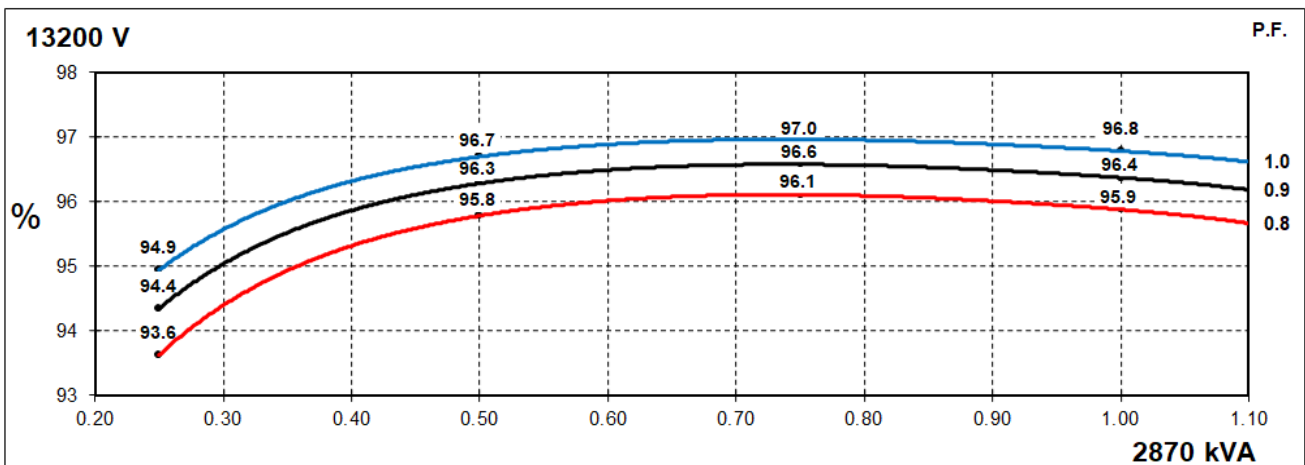
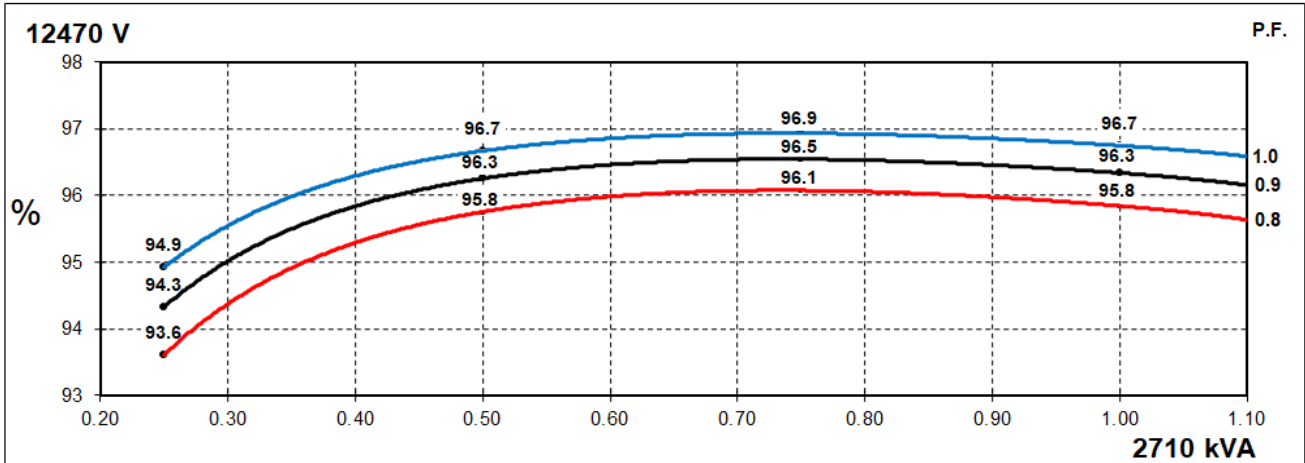

STAMFORD

S9H1D-C4 Wdg.91

Locked Rotor Motor Starting Curves - Separately Excited

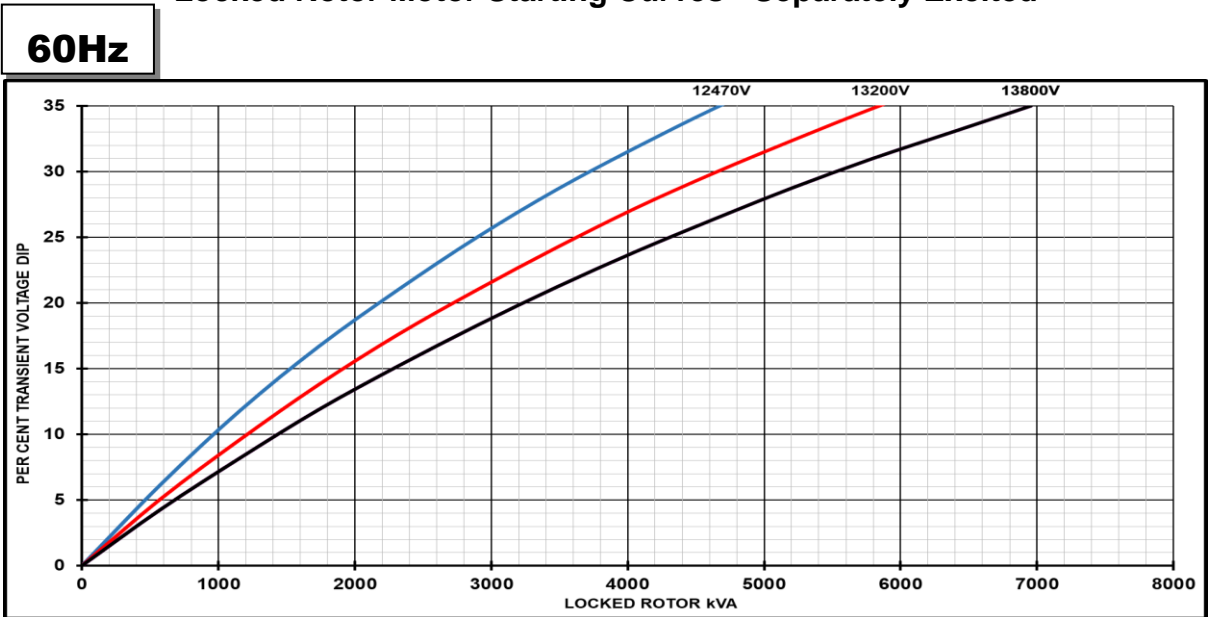

Transient Voltage Dip Scaling Factor		Transient Voltage Rise Scaling Factor
PF	Factor	For voltage rise multiply voltage dip by 1.25
< 0.5	1	
0.5	0.97	
0.6	0.93	
0.7	0.9	
0.8	0.85	
0.9	0.83	

STAMFORD®

S9H1D-C4 Wdg.91

Three-phase Short Circuit Decrement Curve - Separately Excited

60Hz

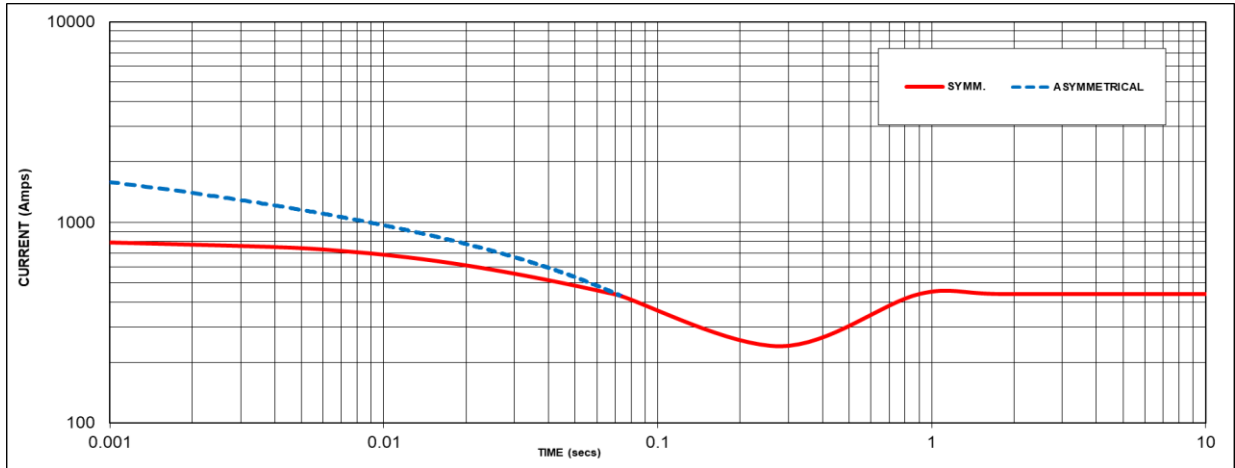

Sustained Short Circuit = 440 Amps

Note 1

The following multiplication factors should be used to adjust the values from curve between time 0.001 seconds and the minimum current point in respect of nominal operating voltage :

50Hz		60Hz	
Voltage	Factor	Voltage	Factor
-	-	12470V	X 0.90
-	-	13200V	X 0.95
-	-	13800V	X 1.00
-	-	-	-

The sustained current value is constant irrespective of voltage level

Note 2

The following multiplication factor should be used to convert the values calculated in accordance with NOTE 1 to those applicable to the various types of short circuit :

	3-phase	2-phase L-L	1-phase L-N
Instantaneous	x 1.00	x 0.87	x 1.30
Minimum	x 1.00	x 1.80	x 3.20
Sustained	x 1.00	x 1.50	x 2.50
Max. sustained duration	10 sec.	5 sec.	2 sec.

Note 3

All other times are unchanged

Curves are drawn for Star connections under no-load excitation at rated speeds. For other connection (where applicable) the following multipliers should be applied to current values as shown :

Parallel Star = Curve current value X 2

Series Delta = Curve current value X 1.732

STAMFORD®

S9H1D-C4 Wdg.91

Typical Alternator Operating Charts

13800V/60Hz

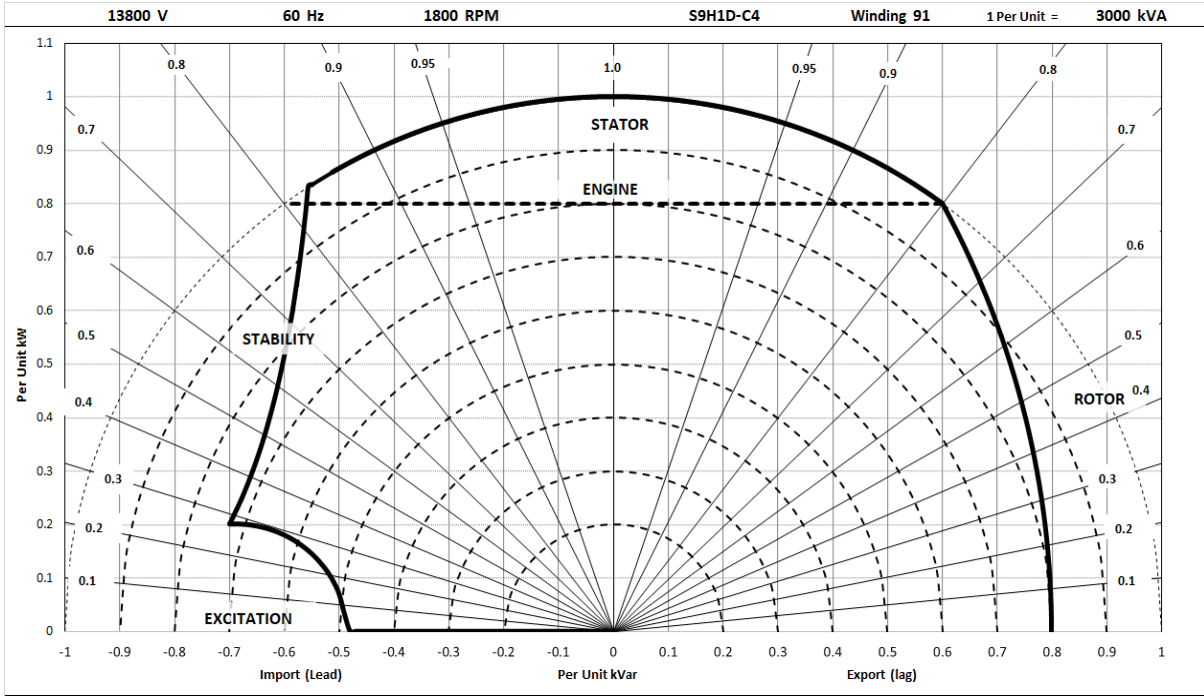

STAMFORD[®]

S9H1D-C4 Wdg.91

RATINGS AT 0.8 POWER FACTOR

Class - Temp Rise		Standby - 163/27°C	Standby - 150/40°C	Cont. H - 125/40°C	Cont. F - 105/40°C
50 Hz	Star (V)	N/A	N/A	N/A	N/A
	Parallel Star (V)	N/A	N/A	N/A	N/A
	Delta (V)	N/A	N/A	N/A	N/A
	kVA	N/A	N/A	N/A	N/A
	kW	N/A	N/A	N/A	N/A
	Efficiency (%)	N/A	N/A	N/A	N/A
	kW Input	N/A	N/A	N/A	N/A

60 Hz	Star (V)	12470	13200	13800	N/A	12470	13200	13800	N/A	12470	13200	13800	N/A	12470	13200	13800	N/A	
	Parallel Star (V)	N/A	N/A	N/A	N/A	N/A	N/A	N/A	N/A	N/A	N/A	N/A	N/A	N/A	N/A	N/A	N/A	N/A
	Delta (V)	N/A	N/A	N/A	N/A	N/A	N/A	N/A	N/A	N/A	N/A	N/A	N/A	N/A	N/A	N/A	N/A	N/A
	kVA	2981	3157	3300	N/A	2900	3070	3210	N/A	2710	2870	3000	N/A	2493	2640	2760	N/A	
	kW	2385	2525	2640	N/A	2320	2456	2568	N/A	2168	2296	2400	N/A	1994	2112	2208	N/A	
	Efficiency (%)	95.7	95.7	95.7	N/A	95.7	95.7	95.8	N/A	95.8	95.9	95.9	N/A	96.0	96.0	96.0	N/A	
	kW Input	2493	2639	2759	N/A	2424	2565	2682	N/A	2262	2395	2503	N/A	2078	2200	2300	N/A	

De-Rates

All values tabulated above are subject to the following reductions:

- 5% when air inlet filters are fitted
- 3% for every 500 meters by which the operating altitude exceeds 1000 meters above mean sea level
- 3% for every 5°C by which the operational ambient temperature exceeds 40°C @ Class H temperature rise (please refer to applications for ambient temperature de-rates at other temperature rise classes)
- For any other operating conditions impacting the cooling circuit please refer to applications

Note: Requirement for operating in an ambient exceeding 60°C and altitude exceeding 4000 meters (for <690V) or 1500 meters (for >690V) must be referred to applications.

Dimensional and Torsional Drawing

For dimensional and torsional information please refer to the alternator General Arrangement and rotor drawings available on our website (<http://stamford-avk.com/>)

Note: Continuous development of our products means that the information contained in our data sheets can change without notice, and specifications should always be confirmed with Cummins Generator Technologies prior to purchase.

Standard features

- Engine
- Radiator 50°C max, fans are driven by belt
- 24V charge alternator
- Alternator: single bearing alternator IP23, insulation class H/H
- Standard auto control system
- One set of air filter, fuel filter, oil filter
- Main line circuit breaker/MCCB
- Base fuel tank
- Two 24V batteries, rac and cable
- Exhaust system(Ripple flex exhaust pipe, exhaust siphon, flange, muffler)
- User manual

Options

- Battery charge
- Engine heater
- Alternator heater
- PMG
- Water oil separator
- Daily fuel tank
- Remote control panel
- Automatic transfer switch/ATS
- Switch box
- Standard: ● Options: ○

Warranty

CUMMINS ENGINE

12 months from date of purchase and 1000 hours.

Generator

12 months from date of purchase or 1000 hours (whichever occurs first).

Dimensions

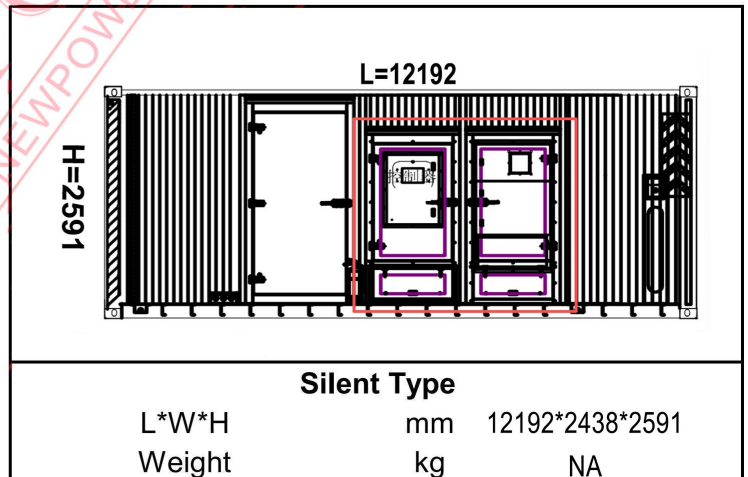
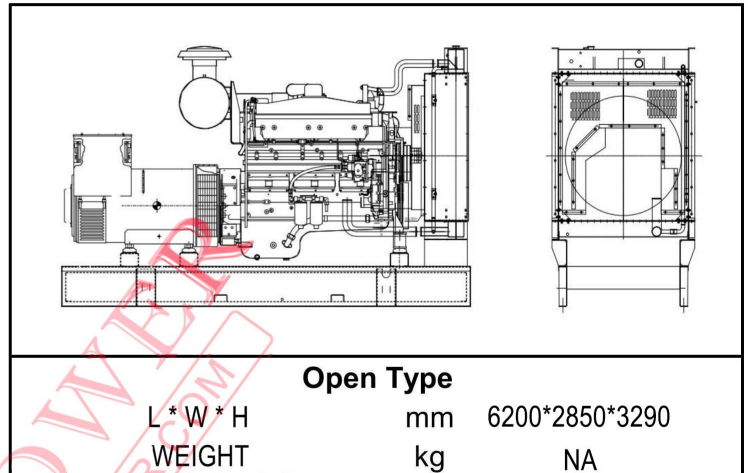

ONEWPOWER

ADD: NO . 1 0 7 XIYUAN ROAD , JINAN DISTRICT, FUZHOU CITY, FUJIAN, CHINA

Phone: 15980204507 E-mail: jina@onewpower.com

WWW.ONEWPOWER.COM

